



Deluxe Pergola *by* London Stone

► Installation Guide

Version 1.0



London Stone[®]

How beautiful gardens begin

Deluxe Pergola

by London Stone

Embarking on the journey of installing an aluminium pergola can transform your outdoor space into a stylish and inviting retreat. Whether you're seeking to create a serene garden nook, a lively entertainment area, or simply a shaded sanctuary to escape the midday sun, an aluminium pergola provides both an elegant focal point and a functional structure to your backyard. This guide is crafted to navigate you through the installation process, providing step-by-step instructions to ensure that your aluminium pergola is not only aesthetically pleasing but also professionally installed and built to last, allowing you to enjoy the outdoors in comfort and style.

WARNING

This installation is highly technical and requires a high level of skill and expertise. It is highly recommended this installation is carried out by competent professionals with experience in the construction of outdoor installations. Attempting to install a metal pergola without the necessary skills can lead to structural issues, potential personal injury, or damage to your property. Ensure that you have thoroughly read and understood these instructions before commencing any work. If in doubt, seek professional assistance to guarantee the safety and integrity of your pergola structure.

 **Please note:** A fully qualified electrician will be required to connect the control board located in post A within the pergola and must be installed according to local regulations. This unit should be earthed. Anyone working on this unit should read the guides and all literature provided prior to any work taking place.

During the install process care should be made not to damage the electrical cables as this could lead to serious injury or death. The electrician should ensure the unit is safe and earthed as part of the testing process.

Stage	Page
Tools Required	3
Preparation	4
1 Fixing to the floor/setting out	5
2 Preparing the posts	5
3 Placing the posts	8
4 Fixing the beams	8
5 Fixing the gutters	11
6 Fitting the led lights	14
7 Installing the blinds part 1	16
8 Installing the flashing	19
9 Preparing roof louvres for installation	20
10 Fitting the louvered roof panels	21
11 Fixing drive rod	23
12 Installing optional heater	23
13 Commission power supply to pergola	24
14 Fitting post & corner covers	25
15 Installing the last flashing	26
16 Complete the blind install	27
17 Pergola Plan: 3000x3000mm	30
18 Pergola Plan: 4000x3000mm	31
19 Pergola Plan: 4000x4000mm	32
20 Pergola Plan: 5000x3000mm	33
21 Pergola Plan: 5000x4000mm	34
22 Commissioning Diagrams & Guides	35
23 Somfy App – Curtains Commissioning Guide	37
24 Somfy App – Lights Commissioning Guide	42
25 Somfy App – Roof Commissioning Guide	45
26 Somfy App – Connectivity Kit Commissioning Guide	49
27 Somfy App – Setting Up Your Equipment	51

Tools required

Tools Required	Qty
Masking Tape	
Tape Measure	
6ft Level	
Large Step Ladders	x 2
Trestle Tables	x 2
Gloves	
Rubber Mallet	
Electric Battery Drills	
Drive Extension For Drill Bit	
3mm Metal Drill Bit	
Assortment Of Screwdrivers	
Ph2 Drill Bit	
Quick Grip Clamps	x 4
Timber Blocks	
Sds Drill	
10mm Concrete Drill Bit	
Eye Safety Ware	
Mastic Gun	
Stanley Knife	
Metal File	

Preparation

Preparation

The installation of a metal pergola requires a level and stable foundation to ensure its structural integrity and longevity. It is imperative that the pergola is erected on a flat area, with a solid base such as a concrete slab or individual concrete footings designed to bear its weight. Attempting to install the pergola on uneven ground or without a proper base can lead to instability and potential collapse, resulting in property damage or personal injury. It is strongly advised that the installation is performed or supervised by professionals who are experienced with such structures and familiar with the local building regulations. Prior to installation, please consult with a qualified builder or installation expert to assess and prepare the site appropriately for your new metal pergola.

Recommendation

For the optimal care of your metal pergola components and to facilitate a smoother installation process, it is recommended that all boxes containing parts are opened and placed on trestles. This approach helps to prevent damage to the components that might occur from opening the boxes on an uneven or hard surface. Additionally, working at a raised level with the use of trestles minimizes the need for excessive bending, making the installation process more ergonomic and less physically taxing. This method not only safeguards the quality of your materials but also contributes to a more efficient and comfortable assembly experience.

⚠ Caution: When opening packaging use a Stanley knife with care to open any packaging. Take care to ensure the blade does not touch and damage the pergola. Keep cuts shallow and away from the contents.

Fixing options

Option 1

The feet plates within the pergola kit can be fixed directly to the ground using the ground bolts provided.

Option 2

Installation using the levelling plates available to purchase separately, these make levelling and positioning the unit extremely easy and are to assist with installations on exterior surfaces where a fall is present.

Locating the Pergola

When deciding which way a pergola is installed, it is important to note the following; The roof has a fall built into the design to enable rain water to be directed towards the gutter in Beam-B where it will flow from the outlet at the bottom of Post-C via drain pipe located in post C. Power supply will need to be provided at Post-A. Normally Beam B will be the front of the pergola and Beam A will be at the rear, however consideration must be made to where the water will flow, which is dependent upon the site and any existing falls on patios.

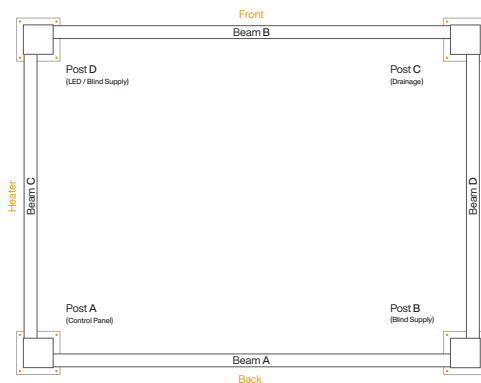

▲ Locating the Pergola

Blind Selection

Due to the wires already coming pre-installed within the pergola beams and the cable holes being pre-drilled into the posts and blind housing, the correct blinds must be selected at time of placing order to ensure they can be fitted as per requirement.

- Beam A = LH Blind
- Beam B = LH Blind
- Beam C = RH Blind
- Beam D = RH Blind

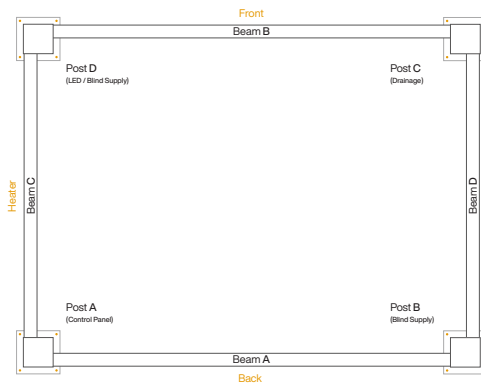

▲ Blind Selection

1 Fixing to the floor/setting out

1.1

Option 1 (Fixed directly to the ground) carry out step 1.2 (Mark the floor as per the floor plan diagram) then skip to step 2.1. Option 2, please follow the full guide.

1.2

Mark on the floor the precise locations for all four pergola posts or adjustable base plates. The adjustable base plates are 20mm smaller (230x230mm) than the bases found on the posts themselves (250x250mm), this will need to be allowed for when setting out. Check the diagonals are equal to ensure squareness.

1.3

Once the positions of the levelling plates are confirmed, fix to ground using the ground bolts provided. You will need to use the SDS drill with 10mm concrete drill bit.



▲ Image 1.3

1.4

The levelling plates are supplied pre-assembled so you will need to remove the top nut and first washer from each threaded bar, these should be set aside for later use.

1.5

The remaining nuts and washers should now be set at the desired finished height by turning the nuts.



▲ Image 1.5

2 Preparing the posts

2.1

Locate the box containing the pergola posts and locate the control panel post (Post A).



▲ Image 2.1

2.2

If you are installing one of our optional heaters, you will need the heater cable supplied with the heater, which is contained within the box marked 'heater'. If you do not have a heater skip to step 2.4.



▲ Image 2.2

2.3

Feed the heater cable through the post ensuring the end of the cable with a connector fitted is at the top of the post, we recommend using a cable rodding kit for this. Take care not to damage the cable.

2 Preparing the posts continued

2.4

At the bottom of the post there is a grommet that will need to be cut as per the cross using a Stanley knife.



▲ Image 2.4

2.5

Feed the control panel power supply cable (blue) and if present the optional heater cable (yellow) through the grommet.



▲ Image 2.5

2.6

Locate 'Post C' (drainage post), fit the length of downpipe with shoe attachment into the hopper found inside the drainage post. The pipe should be inserted into the connection so the bottom of the shoe is level with the bottom of the post.



▲ Image 2.6

2.7

The shoe will direct the water out of the drainage post as shown below, ensure the outlet shoe is facing towards the drainage cut-out in 'Post C'.



▲ Image 2.7

2 Preparing the posts continued

2.8

Open the square box that contains the 4 pergola feet.



▲ Image 2.8



▲ Image 2.8.1

⚠ Please note: One of the feet has a circular hole in the center of its base. This specific foot is to allow for water drainage and should be attached to 'Post C'.



▲ Image 2.8.2

The remaining 3 feet have no specific position and can be used on any of the other posts. The feet of the pergola are designed with three closed sides and one open side. The open side should always be oriented to face outward.

2.9

Slide the base into the post until the pre-drilled holes line up.



▲ Image 2.9

2.10

Use 4no. M10 30mm colour matched post bolts from the accessories box to fix the post to the foot. All four bolts should be finger tight first before tightening using the ratchet spanner provided. Repeat with all posts and feet.

3 Placing the posts

3.1

Place the assembled posts into their correct positions using the floor-plan specific to your pergola. If using fixing **option 2**, the levelling plates should already have been fixed to the ground and the feet can be placed on to the plates now, with a washer and bolt to hold loosely in position. Do not yet tighten.

⚠ Please note: There are several holes at the top of the posts. These holes are designed for attaching the posts to the beams. When verifying the final positions of your posts, ensure that these holes are on the inside.



▲ Image 3.1



▲ Image 3.1.1

4 Fixing the beams

4.1

Locate the box labelled 'Beams A/B', place on the trestles and unbox.

4.2

Untuck the cables from the holes on both ends of the beams, **DO NOT PULL OUT.**

4.3

The first beam to install is beam A (the back beam). Beam A is the beam that contains the roof motor and is easily identifiable by the 3 large bolts on the top side (see image 4.3).



▲ Image 4.3



▲ Image 4.3.1

4.4

Before attempting to install Beam A, check the temporary bracket securing bolt (located at the top of each post) is not in the way (see image 4.3.1). If the bolt securing the bracket is in the way of fixing the beam to the post, move the bolt to an adjacent side. Whilst relocating the bolt ensure the bracket does not fall inside the post. The lower hole on the bracket should line up perfectly with the hole in the post as this is where the electrical cables pass through. If this is not aligned the cables and plugs will not pass through.

4 Fixing the beams continued

4.5

Locate the 30mm M10 bolts, split washers and flat washers and assemble 32 (8 for each post).

⚠ Please note: Note that the split washer should go on the bolt before the washer. (See image 4.5)



▲ Image 4.5

4.6

Using step ladders 2 people need to pick the beam up and offer it into position. The small square cut outs along the inside edge of the beam must be facing inwards and be at the top of the beam.

4.7

Thread the cables coming from the end of the beam through the hole in the post and feed out through the top of the post. On 'Post A' end of the beam the black/red plug should pass through into the post first followed by the cable with the white label.



▲ Image 4.7



▲ Image 4.7.1



▲ Image 4.7.2



▲ Image 4.7.3

4 Fixing the beams continued

4.8

Fit one bolt in each side to initially secure the beam in position before adding the remaining 3 bolts on each beam end, these should be finger tight only at this stage.



▲ Image 4.8

4.9

Fit Beam B, using the same process described for beam A. Beam B should be positioned opposite Beam A. The small squares should also be facing inside and at the top of the beam.

4.10

Now that the fixing of the back and front beams has secured the internal post brackets, remove altogether the temporary bolts that were holding up the internal posts brackets.

4.11

Locate the box labelled 'Beams C/D', place on the trestles and unbox.

4.12

One of the beams will have a heating cable (yellow label) coming out of the centre of the beam, this is beam C. If you are not installing a heater, you can remove this cable now by pulling out. If you have a heater this cable can be left alone.

4.13

UNTUCK any cables from the holes on both ends of the beams.
DO NOT PULL OUT.

4.14

Install beams C & D following the same procedure used for Beams A & B. Thread any cables emerging from the beam end through the hole in the post and pull them out through the top of the post. If there are both cables and plugs to thread, always thread the plug first.



▲ Image 4.14

4.15

Now that all the beams are bolted into position, check that the feet haven't moved from their original positions. If they have moved, gently maneuver them back into position and check all dimensions of the openings and diagonals from post to post are correct.

4.16

If using the levelling plates, it is now time to ensure they are set correctly at the desired finished height. The nuts should be fully tightened ensuring all feet are set at the same height and that the posts are straight. Any leaning posts may impact on the operation of electric blinds if fitted.

4.17

If fixing the plates directly to the floor these should now be fixed to the ground using the anchor bolts provided, shims or spacers may be required to ensure the posts are straight up and not leaning, which will depend on the concrete footing. All feet plates must be set at the same height and the posts are straight. Any leaning posts may impact on the operation of electric blinds if fitted.

4.18

Now the bolts fixing the beams & posts together should be tightened. Whilst tightening the bolts, ensure the edges of the posts and side beams are flush and align neatly. Clamps may be helpful at this point.

4 Fixing the beams continued

4.19

If using the levelling plates once the nuts are tightened use a grinder to cut off excess thread.

4.20

Fit the bolt covers as shown below.



▲ Image 4.20

5 Fixing the gutters

5.1

Locate the box labelled 'Gutters, Flashing & Drive Rod' and open contents on the trestles. Set aside both flashings and the drive rod (see image 5.1).



▲ Image 5.1



▲ Image 5.1.1

5.2

Unpack the gutters from the bubble wrap. One of the gutter units has a small circular hole in the corner to feed the cable for the LED light strip through (see image 5.2). This gutter should be attached to beam C between posts A & D.



▲ Image 5.2

5 Fixing the gutters continued

5.3

The remaining three gutter channels do not have a designated position and can be placed in any location, ensure they correspond with the correct size beam.

On the inside of the beams is a small lip, the gutters should sit on the inside of the beams and be pushed up so that the top inside edge of the gutter is tightly against the lip. Use clamps and blocks of wood in 3 places (middle and both ends) to hold the gutters in the correct position. The underside of the gutter should be flush to the underside of the beam which it is being fixed to. Check the position of the gutter is centred to the opening before clamping and fixing. The gutters are cut to be a precise fit, sometimes it may be necessary to file the ends down slightly to ensure they align properly at the mitred joints. The aluminium files down readily.



▲ Image 5.3



▲ Image 5.3.1

5.4

Using the M4 16mm screws B, and PH2 drill bit with an extender, screw the gutters to the beams through the pre-drilled holes. Move the clamps and wood blocks as you fix, ensuring there is support next to the fixing point as you set each screw.



▲ Image 5.4

5.5

Using the supplied L shaped brackets and M14 16mm Screw B, join the inside corners of the gutters together (you may need to use a clamp to hold the gutters in the correct positions) (see images 5.5 & 5.5.1).



▲ Image 5.5



▲ Image 5.5.1

5 Fixing the gutters continued

5.6

Sealing the gutters — from the accessories box, locate the pre-cut sections of sealant tape as shown below and apply to the inside corner of each corner.



▲ Image 5.6



▲ Image 5.6.1

5.7

Locate the corner plate and sealant contained within the accessories box, offer up the corner plate and mark around it using a marker pen, remove the corner plate and apply sealant as per below.



▲ Image 5.7



▲ Image 5.7.1

5.8

The corner plate can now be pressed into position, excess should be smoothed and cleaned.



▲ Image 5.8

⚠ Please note: If it is possible to now leave the pergola overnight to allow the corner plates to set it can be beneficial and avoid any splitting of the sealant if the frame should move. If not this step can be completed at a more convenient point, but must be prior to flashing and roof louvres being added as access will be difficult.

6 Fixing the LED lights

6.1

Locate the box labelled 'LED Strip Light'. Remove the light and uncoil completely.

6.2

Feed the LED strip through the top of post D, bring it out through the circular hole on the inside of the post and thread it down through the circular hole in the top of the gutter unit. Take care to avoid damaging the LED strip as you pass this through. Continue until the entire strip light has passed through the hole in the top of the gutter (see image 6.2).



▲ Image 6.2



▲ Image 6.3

6.3

Remove the red plastic cover from the double-sided tape which runs along the inside of the LED channel in the gutter.

6.4

Take the loose end of the LED strip and press into the corner of the adjacent gutter to where the LED strip emerges into the gutter channel. Where the red plastic tape cover has been removed there is a small lip, the LED strip should sit on top of this lip. Be sure to press the LED strip down firmly. Continue to stick the LED light to the exposed double-sided tape all the way round the perimeter of the pergola gutter until the entry hole is reached.



▲ Image 6.4

6.5

Now install the LED light defuser covers. Looking at the cut ends of the cover strips, you will see that one side is wider. The wider part should be on the bottom. The lower edge of the defuser should be pushed into the bottom of the channel, now the top must be pushed into the channel at the top, apply pressure and run the hand along the strip and it will snap into place as the hand moves across the defuser. It is helpful for the defuser to be held up at the correct height and the lower edge to be inserted first, then the top can be snapped into position.



▲ Image 6.5

6 Fixing the LED lights continued



▲ Image 6.5.1



▲ Image 6.6



▲ Image 6.5.2

6.6

Locate the black conduit and use to cover the section of LED light between the gutter and post as shown below.



▲ Image 6.6

⚠ Please note: If you have chosen to install a blind/blinds to your pergola please keep reading. If you are not installing blinds, please skip to section 8.

7 Installing the blinds part 1

7.1

Ensure the blind being fitted has the power supply on the correct side, they can be left or right handed.

7.2

Place the blind box on the trestles, remove the blind and guides.



▲ Image 7.2



▲ Image 7.2.1

7.3

Remove the blind cover retaining screws from the blind housing, there is one at each end. Now remove the cover and set aside. Now remove the blind cassette from it's housing. Unscrew the 2 screws from the motor end of the blind (see image 7.3.1) and set aside.



▲ Image 7.3



▲ Image 7.3.1

7.4

Now remove the cassette from the housing and set aside.

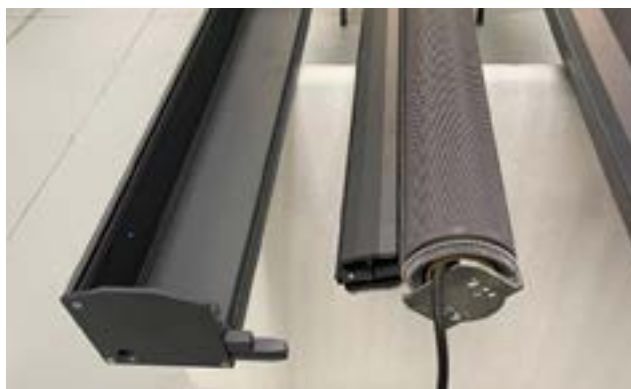

▲ Image 7.4

7.5

The housing now needs to be screwed to the underside of the beam. Clamp the housing to the beam ensuring the housing is centred between the posts. The front of the blind housing should be flush to the front of the pergola beams as shown below.



▲ Image 7.5

7 Installing the blinds part 1 continued

7.6

Screw the blind housing to the underside of the beam through the pre-drilled holes in the blind housing using the washer head screws supplied in the blind accessories box, these are self-drilling and self-tapping.



▲ Image 7.6

7.7

It's now time to install the blind guide rails. Remove the Alan key screws, the blind guide cover and the inner rail and set aside. Handle the inner rail carefully and ensure the black foam pieces on the inner track are not knocked off.

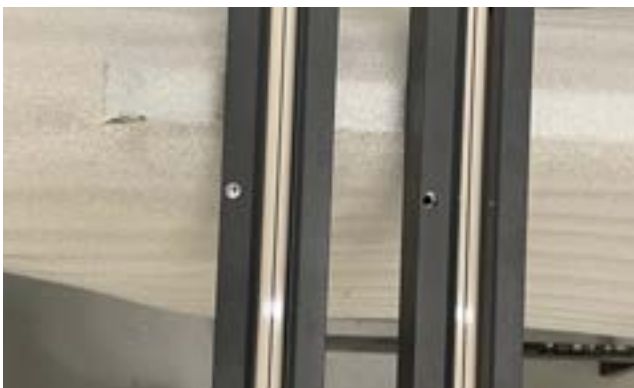

▲ Image 7.7



▲ Image 7.7.1

7.8

Holding the blind guide at an angle, slide onto the corresponding lug on the blind housing. As the blind guide is worked into position the locating lug on the underside of the blind housing will slot down inside the blind guide.



▲ Image 7.8



▲ Image 7.8.1

7.9

Slide the blind guide up so it's in contact with the blind housing. Check that the edge of the rail cover is flush with the edges of the main posts and clamp into position. Use M4 16mm screws located in the blind accessory box to fix the blind guide into place.

7 Installing the blinds part 1 continued

7.10

Once both blind guides are fixed into place the blind cassette should be fitted back into the into the housing. Insert the shaft end of the blind first, then offer up the opposite side, at this point the blind motor cable should be fed through the hole in the side of the blind housing and up through the corner post. The blind cassette can now be slotted in and secured with the two screws which were removed previously.



▲ Image 7.10



▲ Image 7.10.1



▲ Image 7.10.2

7.11

Steps 7.0-7.10 should be repeated until all required blinds are fitted. The blinds are now ready for commissioning and will require a qualified electrician to provide power to the blind to allow correct setup to take place and for the blind guide covers to be replaced. Which is recommended to take place following the completion of the roof to minimise the time spent on site by an electrician.

8 Installing the flashing

8.1

Locate the flashing, which has a U profile, **NOT** an L profile. These were included in the box with the gutters used in step 5. This needs to be fixed to beam D. The flashing is fitted between the beam and the first louvre.

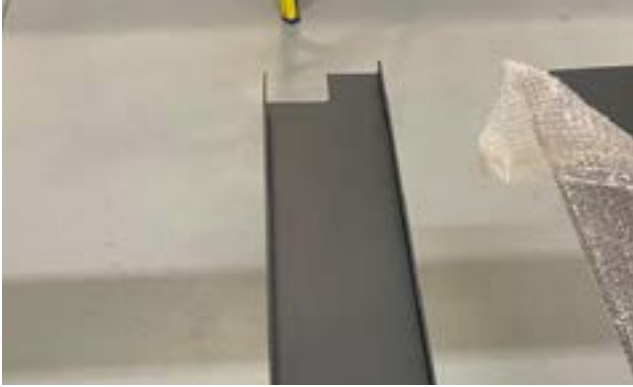

▲ Image 8.1

8.2

Clamp in place with a 10mm fall from right to left. Install the fall by clamping the back of the flashing 15mm from the top of the beam on the right and 25mm from the top of the beam on the left. It should fall away from beam A (which contains the roof motor).



▲ Image 8.2

8.3

Using the self-tapping M4 16mm screws from the accessory pack attach via the pre drilled holes in the flashing.



▲ Image 8.3

9 Preparing roof louvres for installation

9.1

For pergola sizes 4000x4000 & 5000x4000 skip to step 9.5.
For pergola sizes 3000x3000, 3000x4000 & 3000x5000 locate all packs of End cap A and End cap C from the accessories box along with all boxes of louvres.



▲ Image 9.1



▲ Image 9.1.1

9.2

This end of the louvres needs to have End cap C fitted.

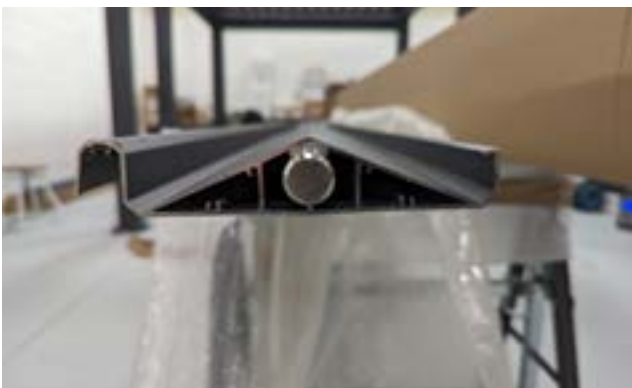

▲ Image 9.2

9.3

Slide the end cap onto the shaft and fix into position using the M4 16mm Screws A supplied.

9.4

Fit End cap A on the opposite end of the louvre. Repeat until all louvres are complete.

9.5

For pergola sizes 5000x4000 & 4000x4000 End Cap A brackets are to be fixed at both ends of louvres as the large pergolas have a drive rod at both ends.

9.6

Locate and set aside the drive louvre/s (one drive louvre for sizes 3000x3000/3000x4000/3000x5000, two drive louvres for 4000x4000, 5000x4000) Drive louvres have a keyed drive shaft at one end. The drive shaft louvres are to be connected to the cam which is attached to the roof motor/s located in Beam A. Familiarise yourself with the location of these cams now by looking down into beam A via the motor inspection access points on the beam top. See 10.6 for fitting details.

It will be located approximately centre of the roof and attaching it to the roof motor is shown in the steps to follow.



▲ Image 9.6



▲ Image 9.6.1

10 Fitting the louvered roof panels

10.1

Locate Brass Bush A from accessory box and fit one in each square hole on Beam A (which contains the roof motor).



▲ Image 10.1

10.2

Locate Brass Bush B and fit one in each square hole on Beam B.



▲ Image 10.2

10.3

The louvres need to be installed flat side down, so that arms on end caps A are upwards on drive beam A. Before fitting the louvre into position, fit one of the white axis washers onto the shaft being fitted into beam A, the motor side.



▲ Image 10.3



▲ Image 10.3.1

10.4

Starting at beam D, slide the louvres into Bush A on the drive side first, then slide back so it sits into Bush B on the opposite side. The Louvre needs to go above the pergola frame for this to work.



▲ Image 10.4.1

10 Fitting the louvered roof panels continued

10.5

As you install the louvers, you will need to install the split pins that are required to keep them in position. These are found in the accessories box and are called "Axis Latch". Using a pair of long nosed pliers, insert the pin into the hole in the shaft. Ensure the split pin is fully inserted and the washer is against the brass bush as shown below.



▲ Image 10.5.1



▲ Image 10.5.2

10.6

When you get to the louvre fitted with the drive shaft, this will need to be installed into the cam on the roof motor as below, use a split pin to secure the drive shaft to the cam, and also to locate the louvre in the same way as all other louvers. Continue until all the roof louvers are fitted.



▲ Image 10.6.1



▲ Image 10.6.2

11 Fixing drive rod

11.1

Turn the drive bar mountings found on end caps A so that the bolts are facing upwards. Loosen all the bolts and starting at one end of the pergola feed the drive rod through the holes in the brackets attached to end cap A. If it's not possible to do this due to obstacles it may be necessary to remove the fittings from end cap A, feed them onto the drive rod, then refit to the end caps with the drive rod already attached. Pergolas of 5000x4000 & 4000x4000 have a drive rod at both ends of the louvres, so this step will need to be repeated for both sides.



▲ Image 11.1



▲ Image 11.1.1

11.2

Ensuring the louvres are sitting flat, they should now be tightened. **DO NOT OVER TIGHTEN.** Check all the bolts on the roof louvre/drive rod connection bracket are also tight.

12 Installing optional heater

12.1

If you are installing a heater, mount the bracket supplied close to the hole in the center of beam C, next to the cable outlet. Use a 3.5mm drill bit for metal to pilot hole the beam, then fix using the washer head screws supplied.



▲ Image 12.1

12.2

Mount the heater onto the bracket using the wing nuts, bolts and washers supplied in the heater box.



▲ Image 12.2

13 Commission power supply to pergola

Installing electrician must read this guide as well as review the wiring diagram and the individual electronic product manuals provided within the accessory packs.

A qualified electrician is required to supply power to the pergola and fully test and earth the pergola in accordance with local regulations. The roof motor and the LED lighting are standard and as such come with connectors pre-fitted. The blinds and heaters are optional and as such do not come pre-fitted, however suitable components are provided to enable a qualified electrician to carry out this work.

If the installation includes blinds and or heaters the plug sockets need to be fitted by an electrician. The cables are already fitted within the beams.

⚠ Please note: During commissioning only one motor can be connected at a time, the plugs provided enable the individual motors to be connected and disconnected easily and safely to aid this process.

Roof Motor

The roof motor is 24V and the transformer and all connections for this are pre-fitted. The roof cables are labelled red and come with different plug connectors to prevent 240V supply being connected and blowing the louvre control box, which is located within Beam A.

LED Lights

The LED lights are 240V and come with all connections pre-fitted, the cable ends are labelled with green stickers.

Heaters

IP67 Cable plug connectors need to be fitted to the heater and the supply cable protruding from Beam C, this cable has a yellow label attached. Supply will also need to be provided to the heater supply cable referenced in step 2.2.

Blinds

If the installation includes blinds, IP67 plug connectors need to be added to each connection and power should be taken from the junction box located on the control panel. There should also be IP67 cable plug connectors fitted to connect the cables pre-installed in the Beams but the exact set-up will be dependent upon the quantity and location of the blinds. When installing more than one blind, the electrician will need to make the connectors to enable the supply to be provided to multiple blinds. All required components are provided. The cables labelled silver are intended to be used for the blinds.

Once the pergola has all the electrical connectors in place, and they have been tested all plugs in the beams should be unplugged to allow commissioning to take place.

Please now refer to the commissioning guides provided before continuing with this guide.

1. LED lights – see pages 37 & 42
2. Roof – see pages 37 & 46
3. Curtains – see pages 36 & 38
4. Heaters – see page 36

14 Fitting post & corner covers

14.1

Place the corner cover into position and clamp, apply masking tape around the cover. Use a 3.5mm drill bit for metal to predrill the top of the beam for the self-tapping screws.

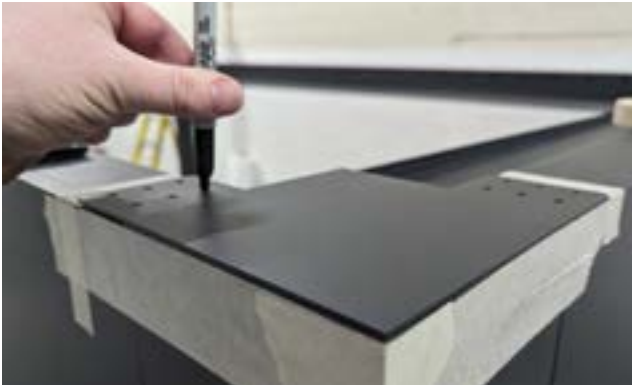

▲ Image 14.1

14.2

Apply sealant supplied in the accessories box to all outer edges as shown.



▲ Image 14.2

14.3

Press the post cover onto the mastic and screw into position using the M4 16mm screws B. Ensure the screws are not overtightened and remove excess mastic and masking tape. Repeat at all posts.



▲ Image 14.3



▲ Image 14.3.1

14.4

Place the motor cover into position and clamp, apply masking tape around the cover and use a 3.5mm drill bit for metal to pre-drill the top of the beam for the self-tapping screws.



▲ Image 14.4

14 Fitting post & corner covers continued



▲ Image 14.4.1

14.5

Apply sealant, supplied in the accessories box, to the outer edges. Fix the cover into position using the M4 16mm screws and remove masking tape and any excess sealant.



▲ Image 14.5

15 Installing the last flashing

15.1

Offer up the end flashing into position and clamp in place, this will be an L profile.

⚠ Please note: The last flashings will be cut differently depending on the size of the pergola being installed so it may differ from the image below.

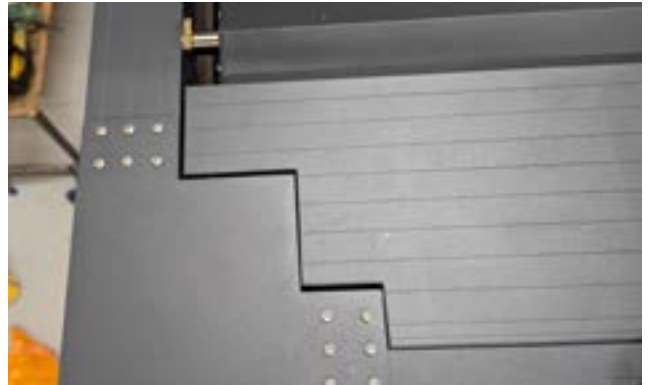

▲ Image 15.1



▲ Image 15.1.1

15.2

Fix the flashing into position through the pre-drilled holes using M4 16mm screws B supplied in the accessories box.



▲ Image 15.2

16 Complete the blind Install

To ensure the blinds function well its vital the following steps are followed closely, the motors have collision detection sensors and will not move down unless they move freely, also the motors have thermal cut-outs and will switch off for around 30mins if they overheat. Commissioning should now be complete with pairing and end limits already set.

16.1

Take the blind up/down until its approximately 300mm from the top as shown.



▲ Image 16.1

16.2

Standing on the inside of the pergola, pull the section of blind that's hanging down towards you to an angle of approximately 45 degrees and slide the inner blind track onto it. Ensure the end of the guide with the 'V' shape notch is at the top.



▲ Image 16.2

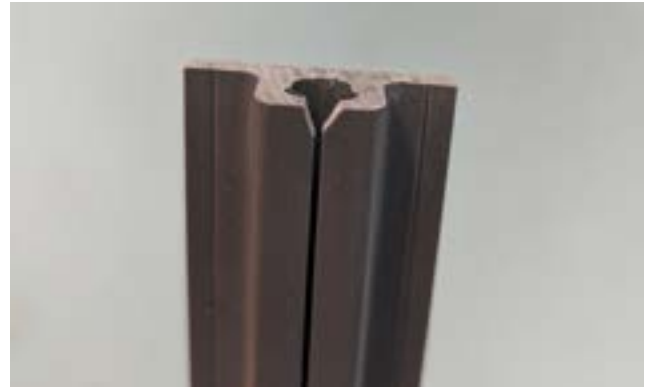

▲ Image 16.2.1

16.3

Insert the inner blind track into the slot on each side. You will need to twist this in so that the outside piece of black foam sits in the cavity behind the lip on the inside of the rail cover and apply silicone lubricant (provided) to the blind track. Complete this step for both sides.



▲ Image 16.3



▲ Image 16.3.1

16.4

Lower the blind all the way to the bottom and then return to the top, ensure the blind is centred between the tracks on either side. If the blind is not correctly centred the blind may snag on the way down and set off the collision detection.

16 Complete the blind Install continued

16.5

Refit the blind housing cover by inserting the top in first and then pushing the bottom down into position.

16.6

Screw the blind cover into place at both ends with the screws previously set aside.



▲ Image 16.6



▲ Image 16.6

16.7

Locate the outer rail cover that was set aside and firmly push it back into position ensuring it is properly located, it should click into position. Fix into position using the Alan Key screws previously set aside.



▲ Image 16.7



▲ Image 16.7.1

16.8

Test the blind is functioning properly by running up and down.

16 Complete the blind Install continued

16.9

Using the sealant supplied, working on the inside of the Pergola where the post meets the blind guide, from the bottom working upwards run a bead of sealant all the way to the top, around the front edge of the blind cover then along the top of the blind housing and all the way back down the opposite side. See images below.



▲ Image 16.9



▲ Image 16.9.1

16.10

Fit the grey screw covers supplied to the blind rails.



▲ Image 16.10

16.11

Fit black blanking plugs to the inside of the posts, where blinds are not fitted.



▲ Image 16.11.1

16.12

Congratulations: the installation is *now* completed.

17 Deluxe Pergola plan view

3000x3000mm

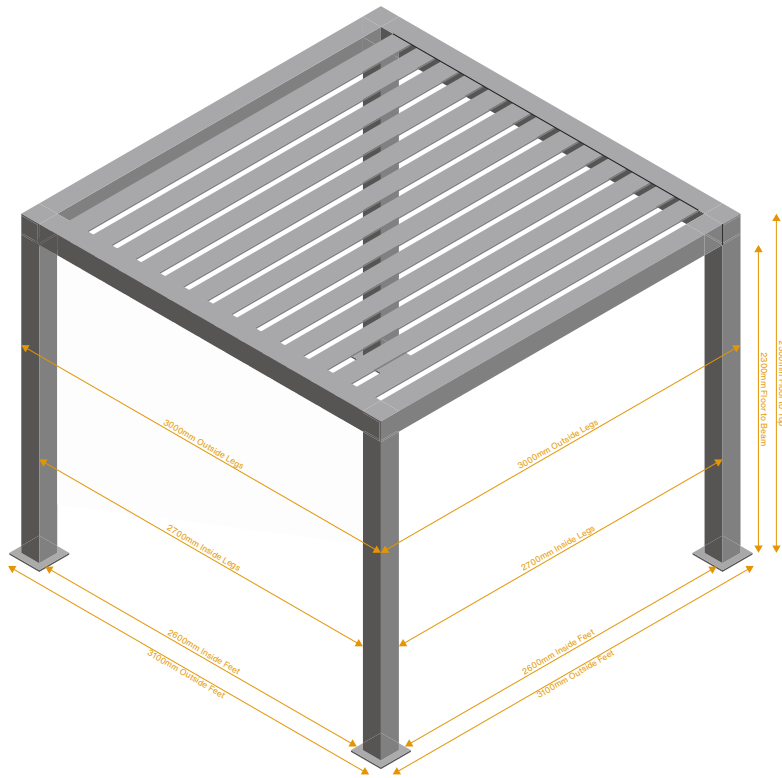

Outside Legs	3000x3000mm
Inside Legs	2700x2700mm
Outside Feet	3100x3100mm
Inside Feet	2600x2600mm
Floor to Top	2500mm
Floor to Beam	2300mm

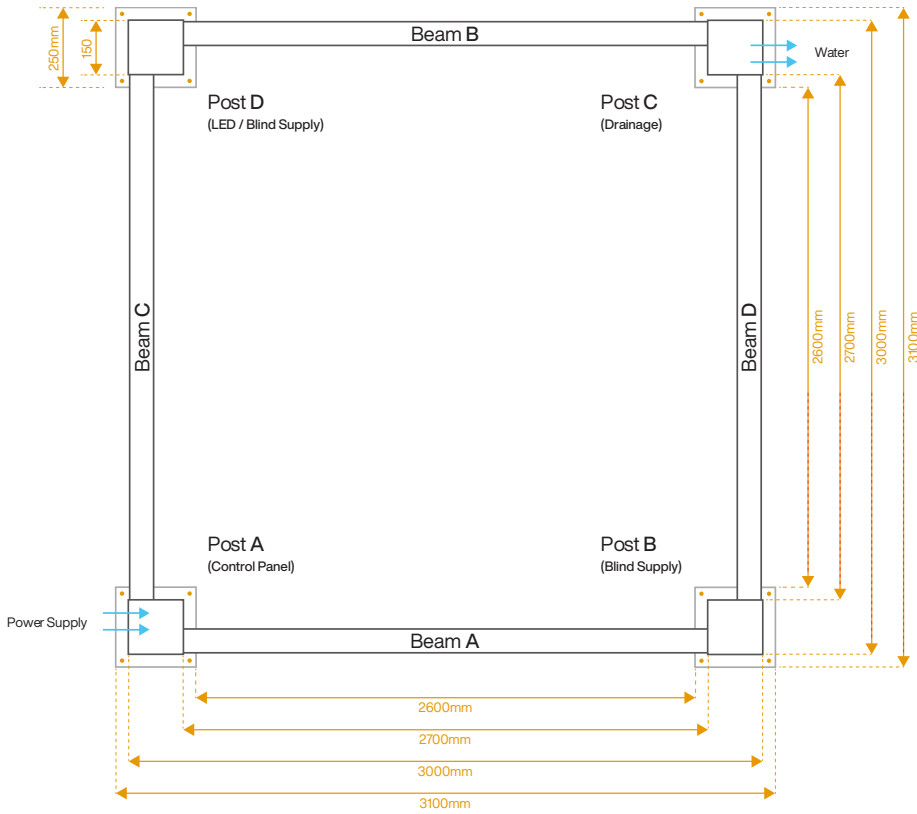

18 Deluxe Pergola plan view

4000x3000mm

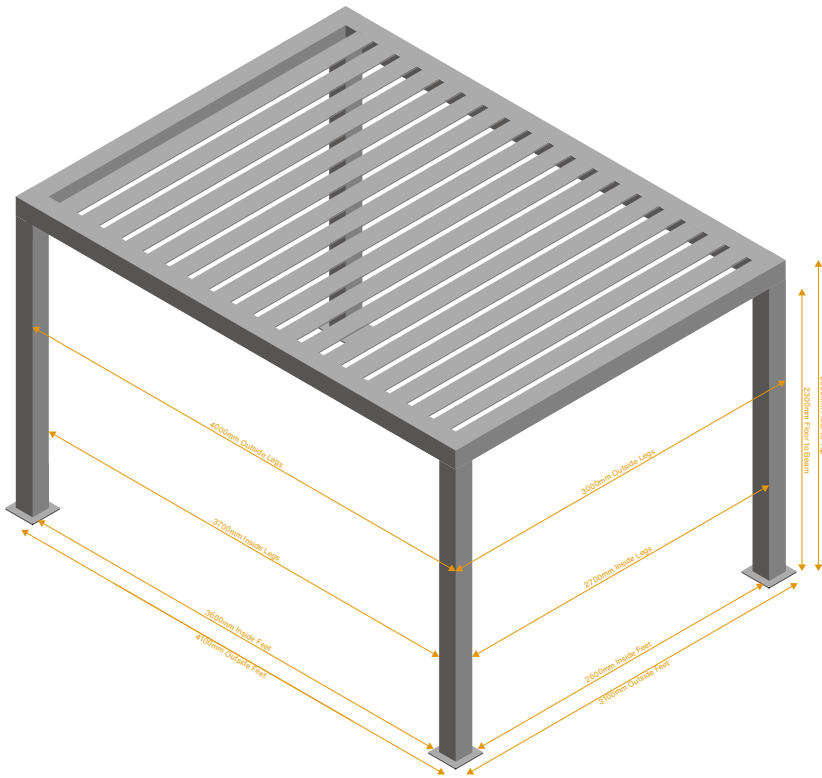

Outside Legs	4000x3000mm
Inside Legs	3700x2700mm
Outside Feet	4100x3100mm
Inside Feet	3600x2600mm
Floor to Top	2500mm
Floor to Beam	2300mm

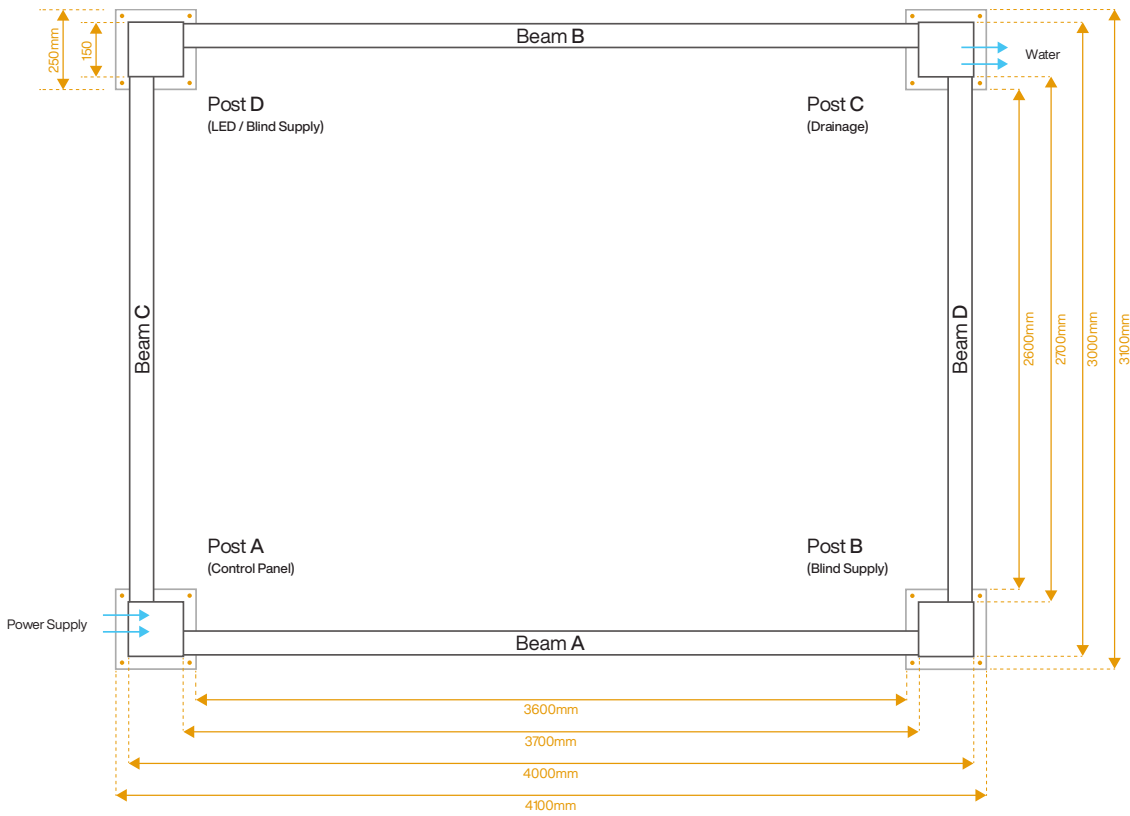

19 Deluxe Pergola plan view

4000x4000mm

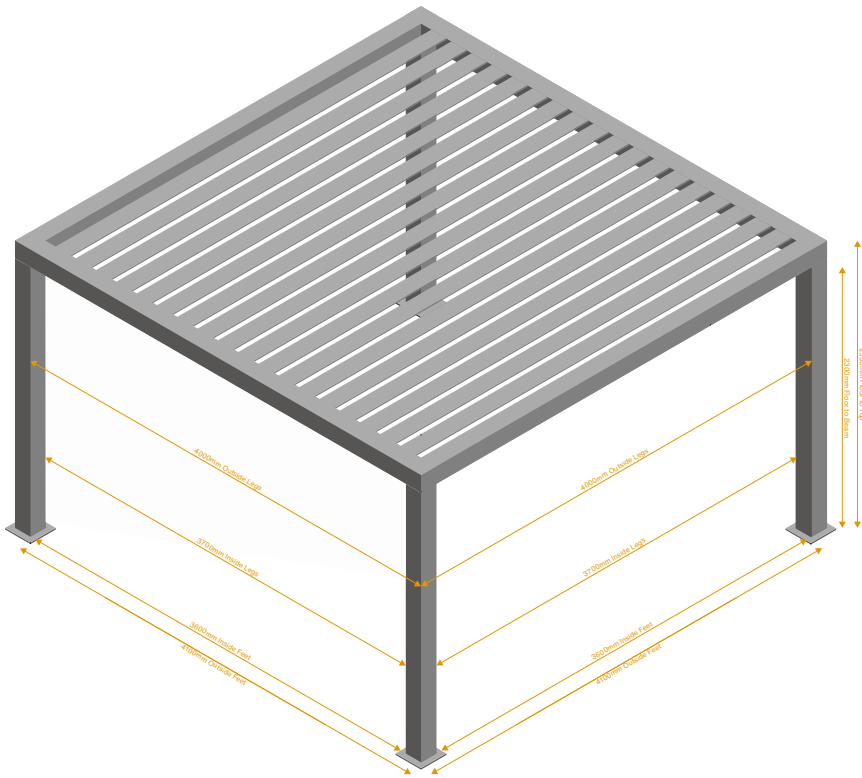

Outside Legs	4000x4000mm
Inside Legs	3700x3700mm
Outside Feet	4100x4100mm
Inside Feet	3600x3600mm
Floor to Top	2500mm
Floor to Beam	2300mm

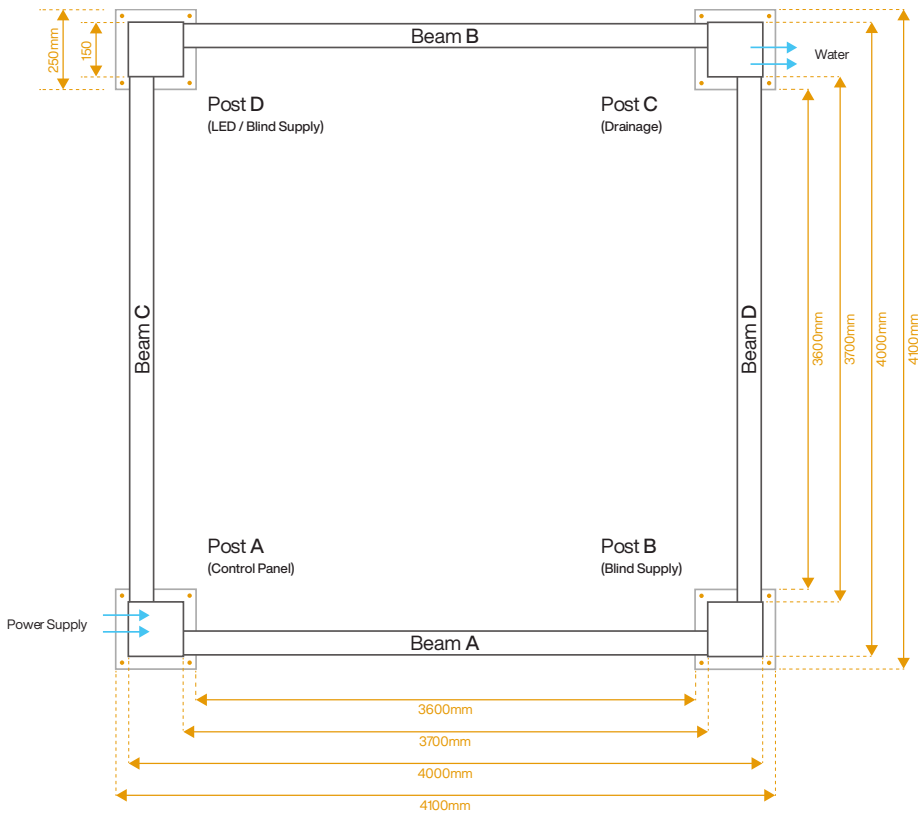

20 Deluxe Pergola plan view

5000x3000mm

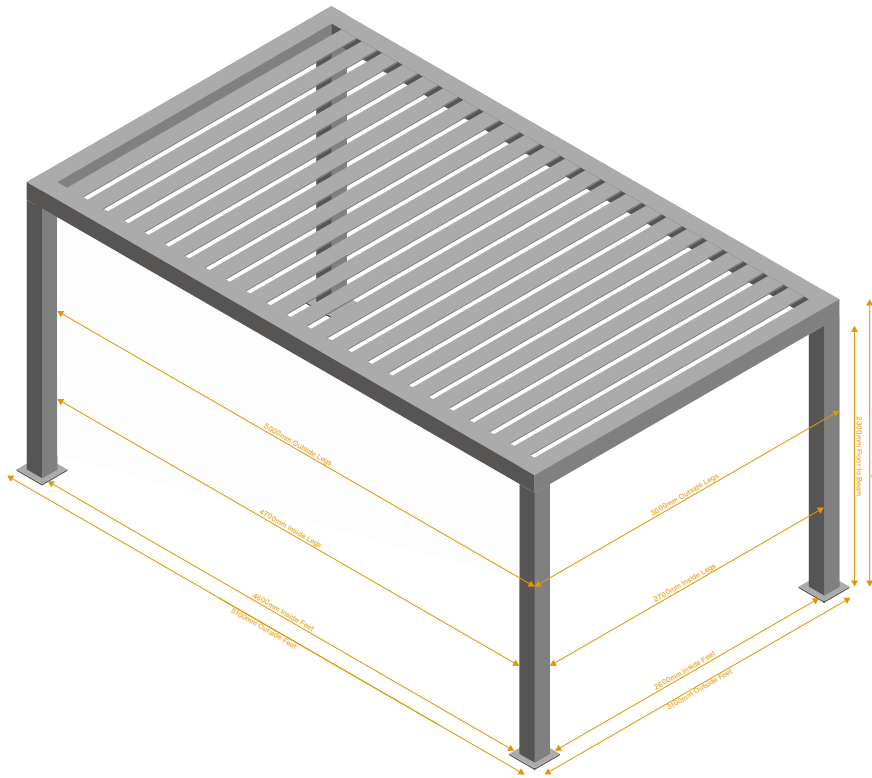

Outside Legs	5000x3000mm
Inside Legs	4700x2700mm
Outside Feet	5100x3100mm
Inside Feet	4600x2600mm
Floor to Top	2500mm
Floor to Beam	2300mm

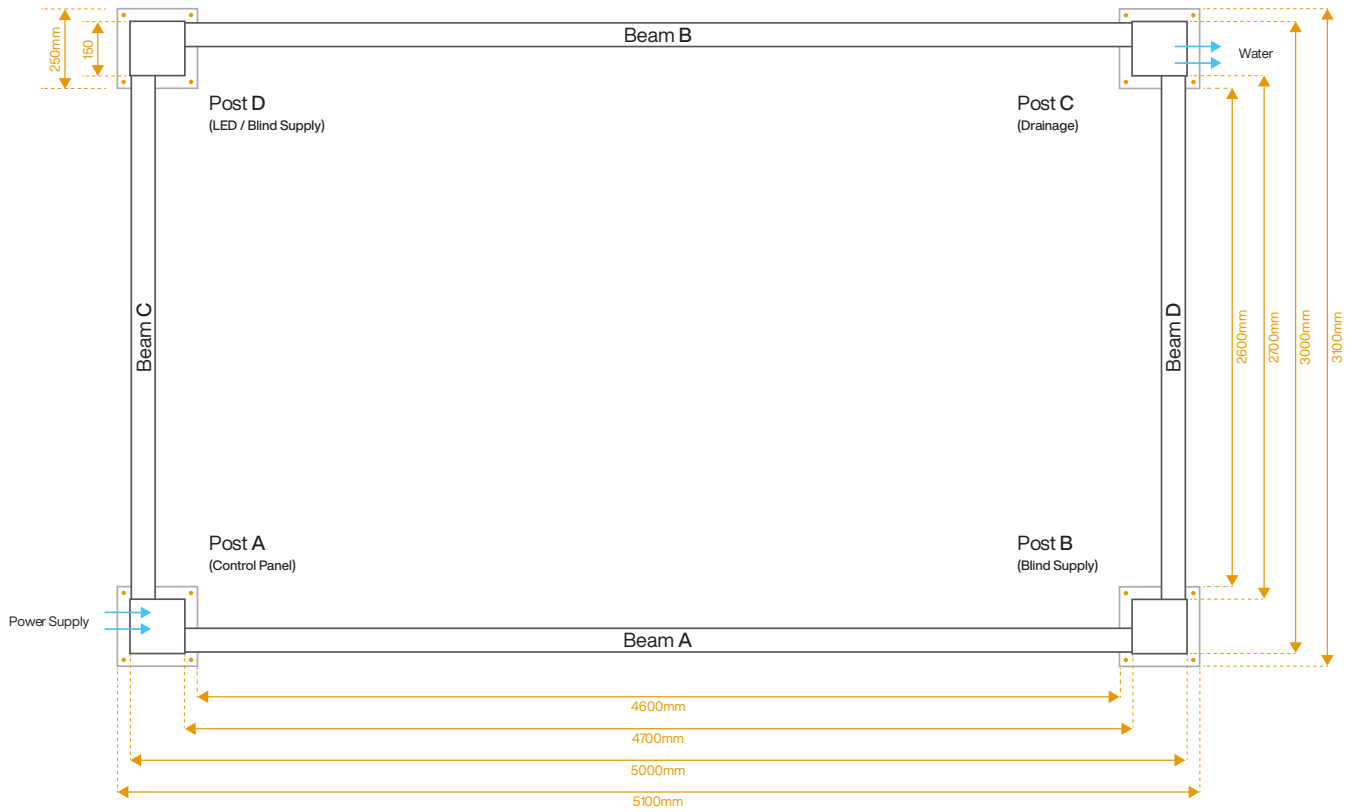

21 Deluxe Pergola plan view

5000x4000mm

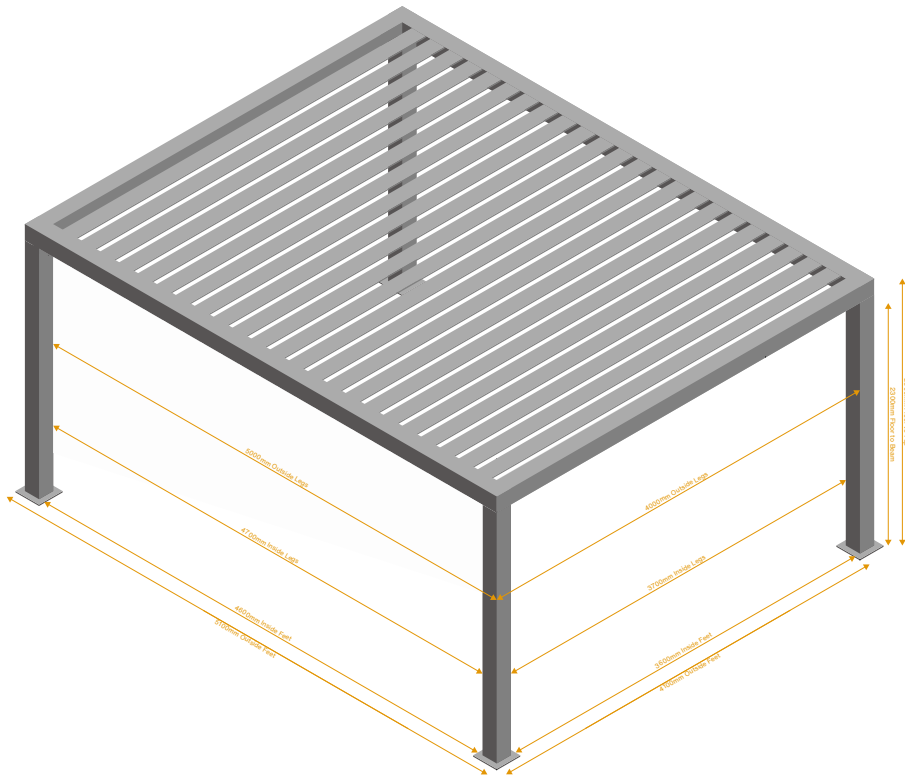

Outside Legs	5000x4000mm
Inside Legs	4700x3700mm
Outside Feet	5100x4100mm
Inside Feet	4600x3600mm
Floor to Top	2500mm
Floor to Beam	2300mm

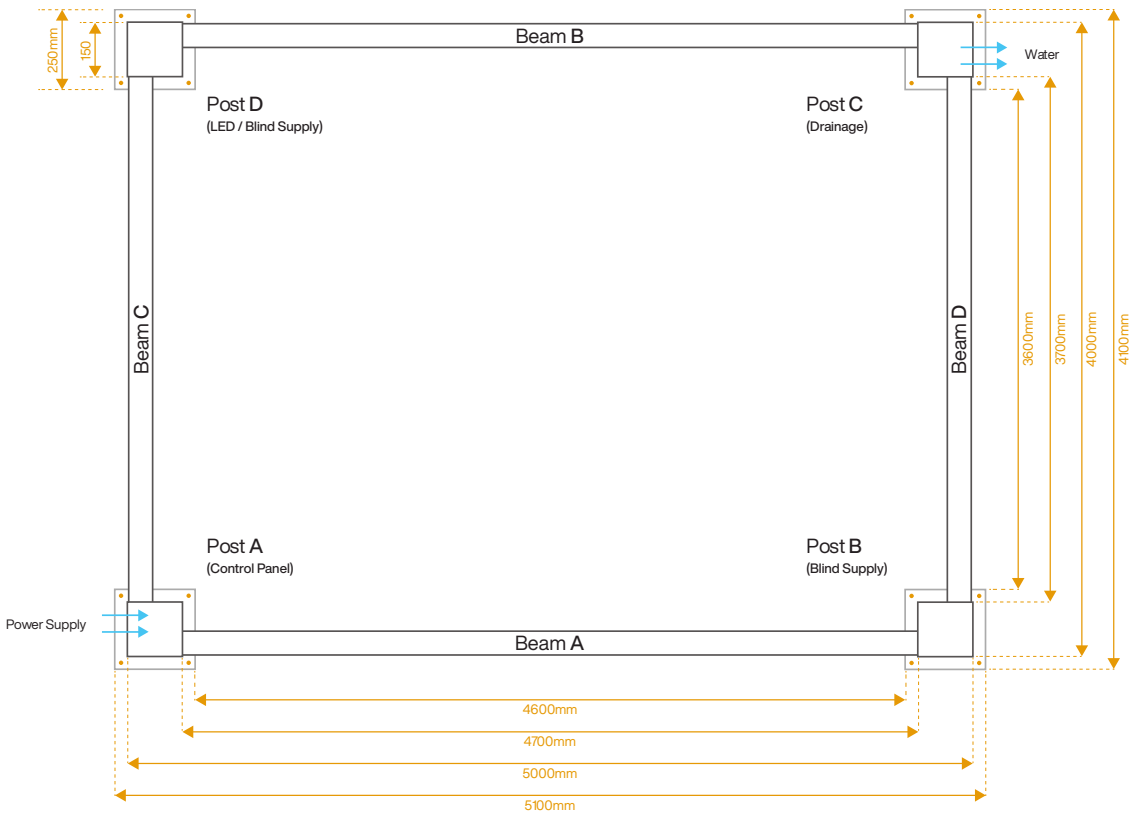

22 Commissioning diagram & guides

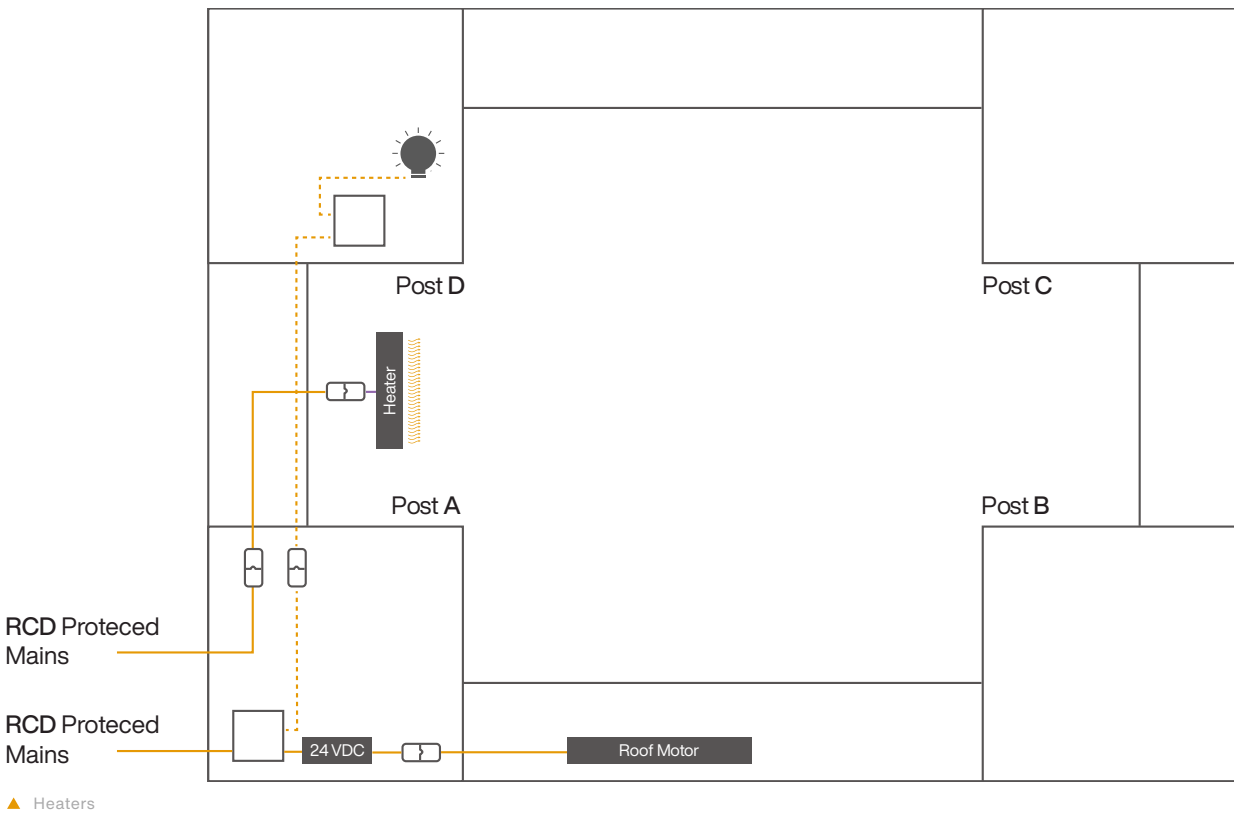
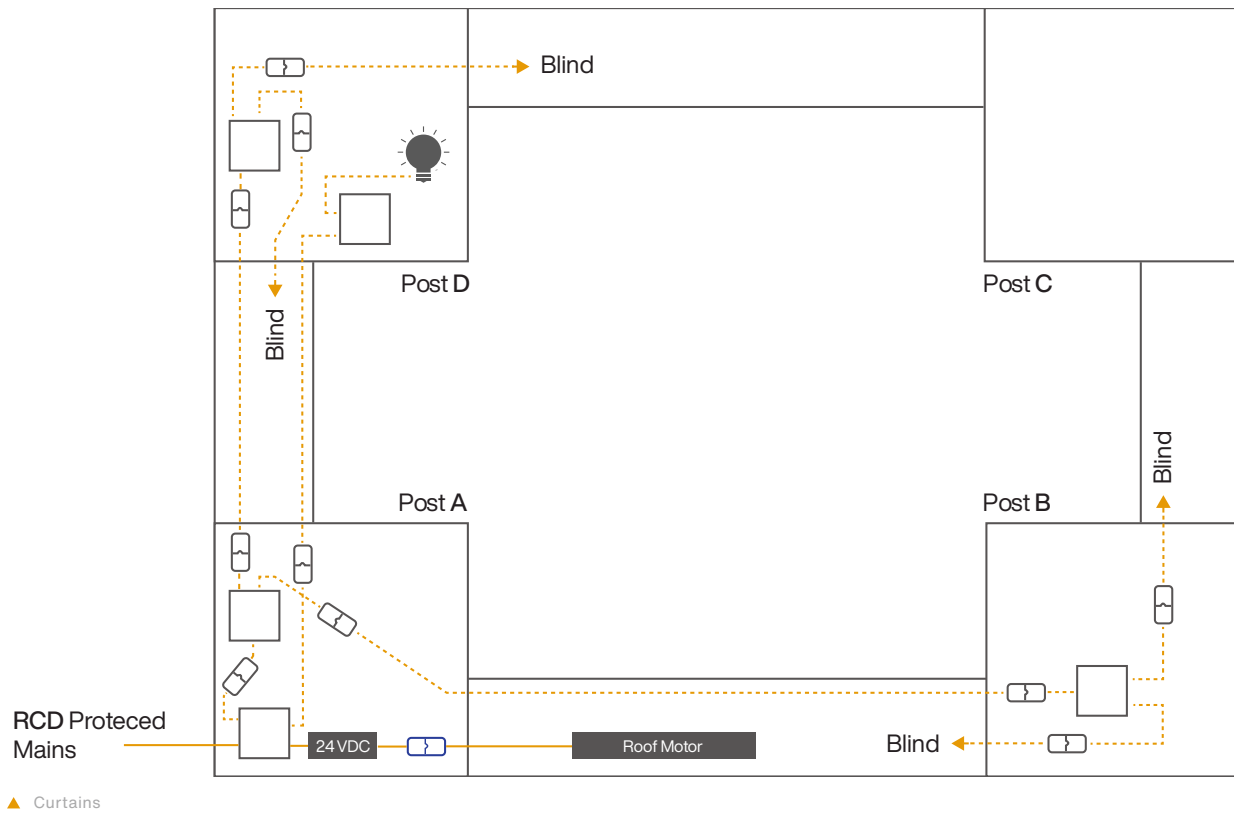

22 Commissioning diagram & guides continued

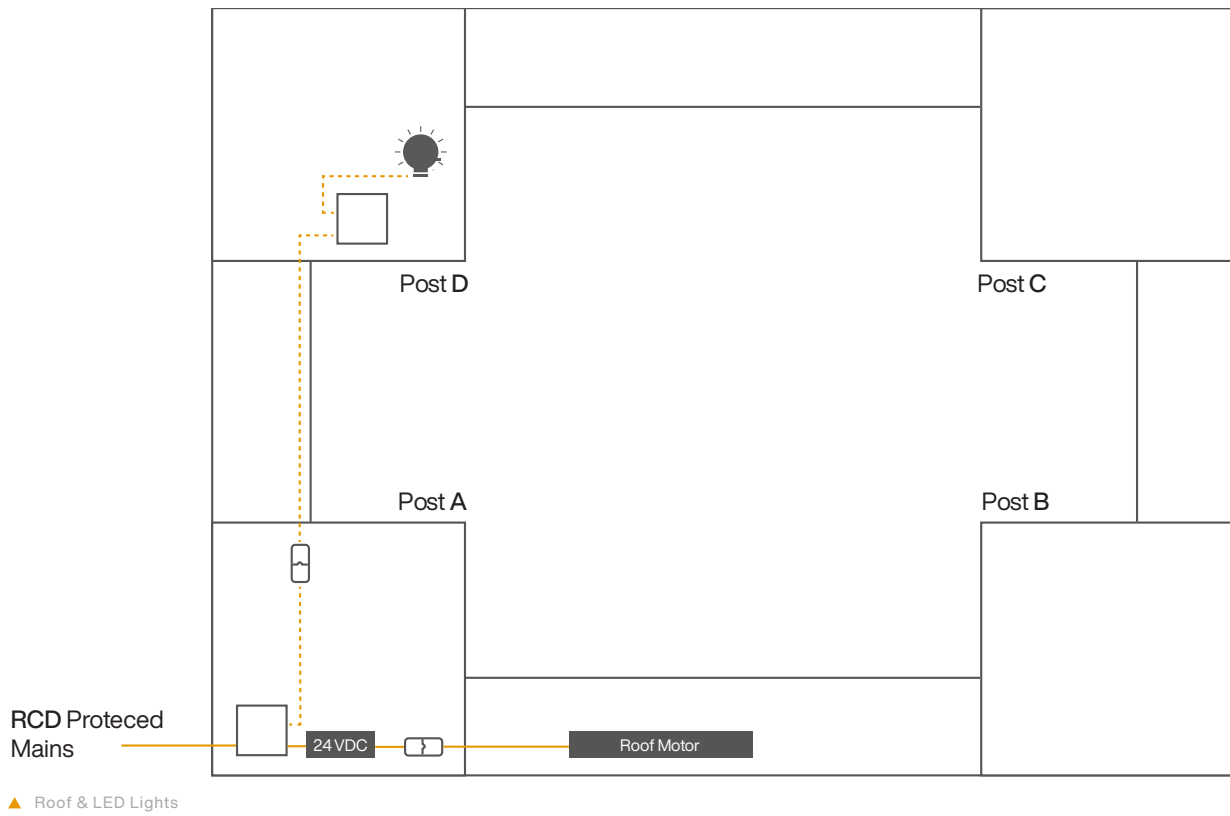

23 Somfy App – Curtains commissioning guide

Throughout Commissioning all other motors/
lights/roof/blinds must be powered off.

⚠ Please note: ONLY one motor can be commissioned
at the same time.

23.1

Search **Somfy Help me** and
Download the app



▲ Image 23.1

23.2

Fill out country and language



▲ Image 23.2

23.3

Select **Initialisation**



▲ Image 23.3

23.4

Choose **select from a list**

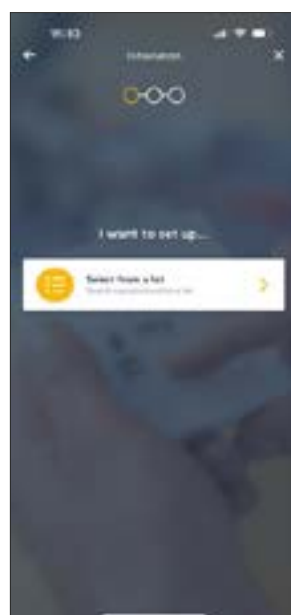

▲ Image 23.4

23.5

Choose **terrace and external
screen**

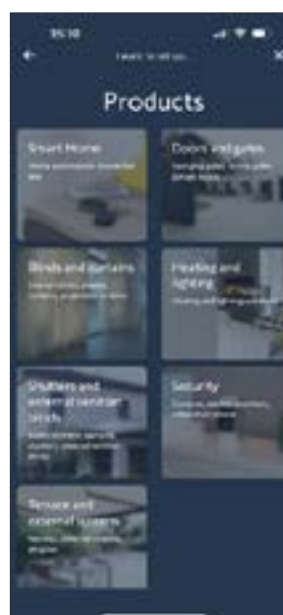

▲ Image 23.5

23.6

Choose **exterior vertical
screen**



▲ Image 23.6

23 Somfy App – Curtains commissioning guide continued

23.7
Choose **select from a list**

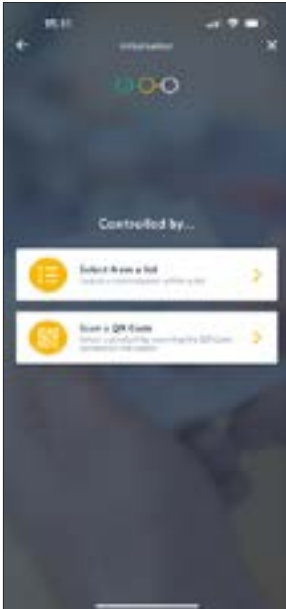

▲ Image 23.7

23.8
Choose **io**



▲ Image 23.8

23.9
Choose **Situo 5 io**



▲ Image 23.9

23.10
Choose **Maestria**



▲ Image 23.10

23.11
Choose **Maestria + 50 io**



▲ Image 23.11

23.12
Choose **see results**

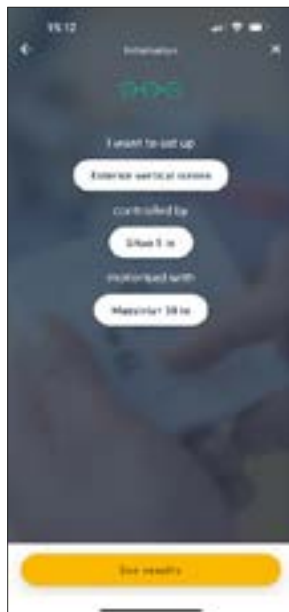

▲ Image 23.12

23.13
Click on **star icon** in top Right corner of screen

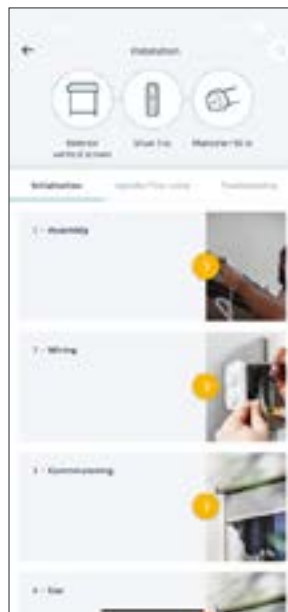

▲ Image 23.13

23.14
The instructions for the blind commissioning are now saved in your **SOMFY library**



▲ Image 23.14

23 Somfy App – Curtains commissioning guide continued

23.15

Choose **commissioning** the app



▲ Image 23.15

23.16

Power on

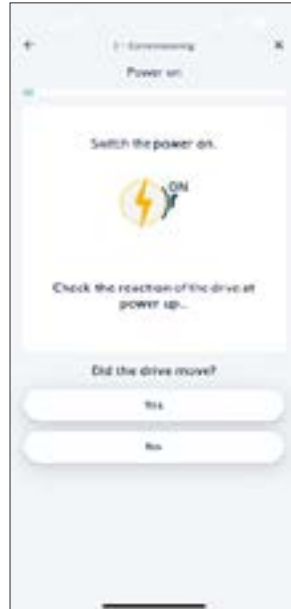

▲ Image 23.16

23.17

Select desired channel on remote, recommend channel 3 onwards

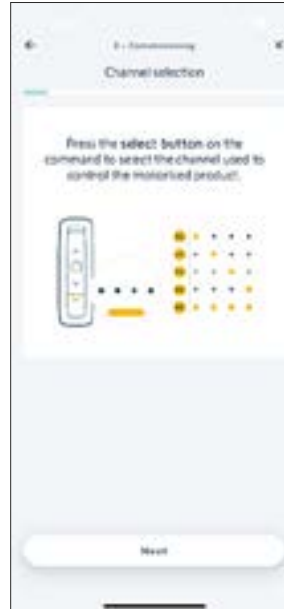

▲ Image 23.17

23.18

Check motor direction is correct



▲ Image 23.18

23.19

Continued



▲ Image 23.19

23.20

Change motor direction if incorrect



▲ Image 23.20

23.21

Choose option **C**

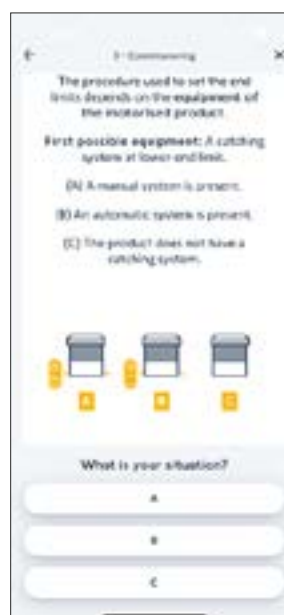

▲ Image 23.21

23 Somfy App – Curtains commissioning guide continued

Positioning the blind on the blind tube

The following steps are critical in ensuring the blind will move smoothly and not snag on the way down, which will enable the motor's collision detection feature. Excessive use of the blind will cause the motor to overheat, which will enable the thermal cut off for approx. 30 mins.

1. Lower the blind all the way to the bottom so all the blind is off the tube.
2. Centre the blind exactly on the tube, ensuring the measurement between both edges of the blind and the bling guide housing are exactly the same.
3. Carefully raise the blind to the mid-way point, ensuring the blind remains centred.

23.22

Choose option **C**



▲ Image 23.22

23.23

Leave a gap of **10-15mm** from the top



▲ Image 23.23

23.24

Minor adjustments



▲ Image 23.24

23.25

Save setting



▲ Image 23.25

23.26

Lower limit setting



▲ Image 23.26

23.27

Minor adjustment



▲ Image 23.27

23 Somfy App – Curtains commissioning guide continued

23.28
Saving setting



▲ Image 23.28

23.29
All setting confirmation

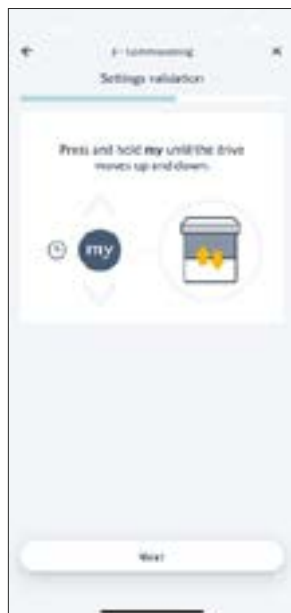

▲ Image 23.29

23.30
Complete process



▲ Image 23.30

23.31
Setting now saved

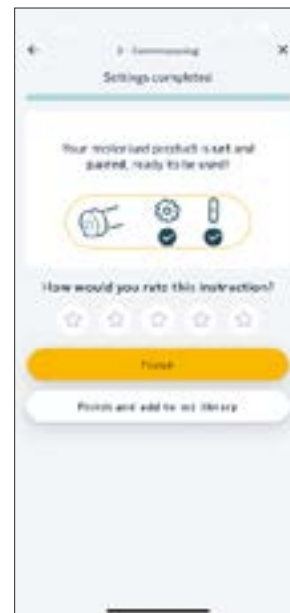

▲ Image 23.31

24 Somfy App – Lights commissioning guide

Throughout Commissioning all other motors/lights/roof/blinds must be powered off. ONLY one motor can be commissioned at the same time. IZYMO receiver is located within the junction box attached to the LED light located in Post-C.

⚠ Please note: Caution this junction box contains live electrical wires.

24.1
Search **Somfy Help me** and
Download the app



▲ Image 24.1

24.2
Fill out country and language



▲ Image 24.2

24.3
Select **Initialisation**



▲ Image 24.3

24.4
Choose **select from a list**

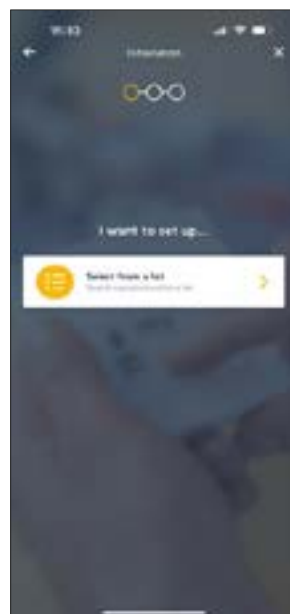

▲ Image 24.4

24.5
Choose **heating and lighting**

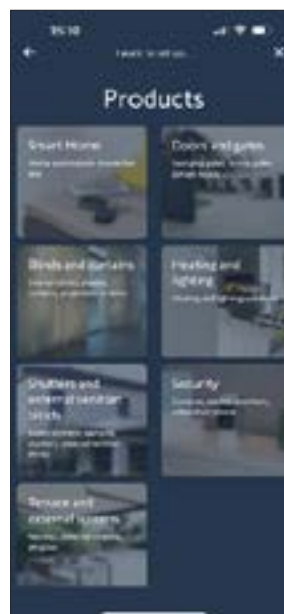

▲ Image 24.5

24.6
Choose **Izymo ON-OFF receiver io**



▲ Image 24.6

24 Somfy App – Lights commissioning guide continued

24.7

click on the small star in the top right to save to library



▲ Image 24.7

24.8

Select **2 Commissioning**



▲ Image 24.8

24.9

Switch power on



▲ Image 24.9

24.10

Select **No**

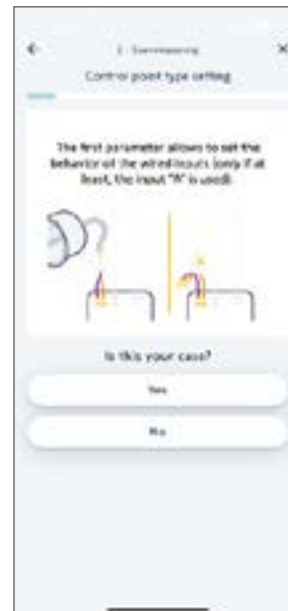

▲ Image 24.10

24.11

Choose **skip this step**



▲ Image 24.11

24.12

Choose **skip this step**



▲ Image 24.12

24.13

Click **next**, as prior sections were skipped this is not required



▲ Image 24.13

24.14

Select **Yes**



▲ Image 24.14

24 Somfy App – Lights commissioning guide continued

24.15

Follow instructions



▲ Image 24.15

24.16

Select **Option B**



▲ Image 24.16

24.17

Select desired channel on remote, recommend to select channel 2

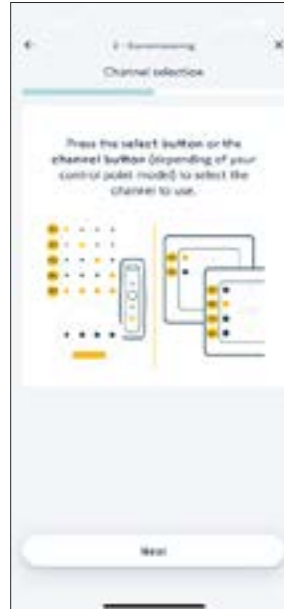

▲ Image 24.17

24.18

Save the settings



▲ Image 24.18

24.19

Settings now saved

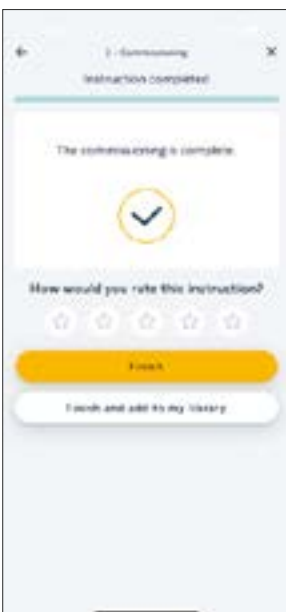

▲ Image 24.19

25 Somfy App – Roof commissioning guide

Throughout Commissioning all other motors/
lights/roof/blinds must be powered off.

⚠ Please note: ONLY one motor can be commissioned
at the same time.

25.1

Search **Somfy Help me** and
Download the app



▲ Image 25.1

25.2

Fill out country and language



▲ Image 25.2

25.3

Select **Initialisation**



▲ Image 25.3

25.4

Choose **select from a list**

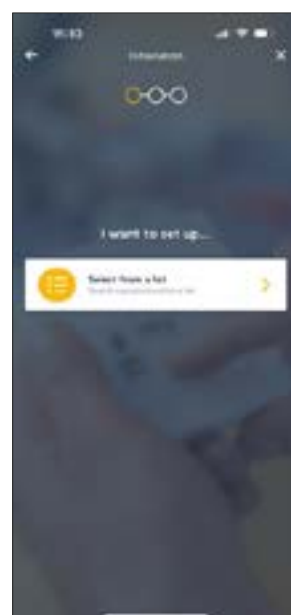

▲ Image 25.4

25.5

Choose **terrace and external
screen**



▲ Image 25.5

25.6

Choose **louvre pergola**



▲ Image 25.6

25 Somfy App – Roof commissioning guide continued

25.7
Choose **select from a list**

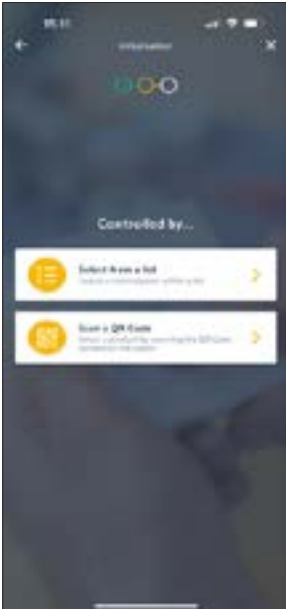

▲ Image 25.7

25.8
Choose **io**



▲ Image 25.8

25.9
Choose **Situo 5**



▲ Image 25.9

25.10
Choose **Situo 5 io**



▲ Image 25.10

25.11
Choose **select from a list**

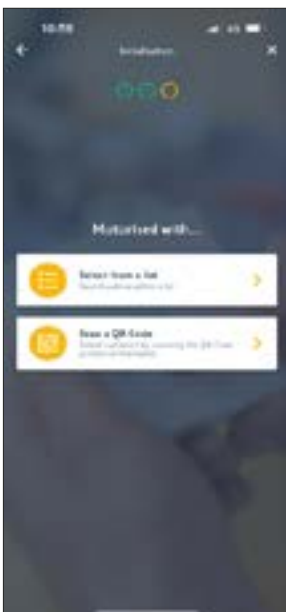

▲ Image 25.11

25.12
Choose **pergola**



▲ Image 25.12

25.13
Select **louvre control io**



▲ Image 25.13

25.14
Click on the **star icon** in the top right hand corner



▲ Image 25.14

25 Somfy App – Roof commissioning guide continued

25.15

The instructions for the blind commissioning are now saved in your **SOMFY library**



▲ Image 25.15

25.16

Power on, choose no

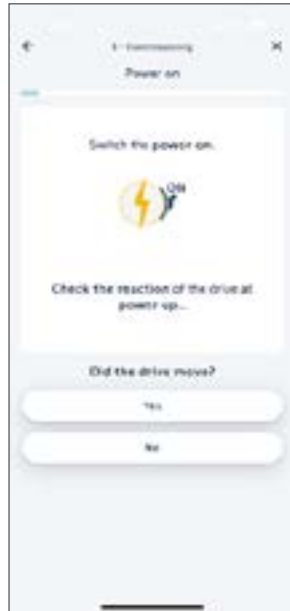

▲ Image 25.16

25.17

Select desired channel on remote, select channel 1

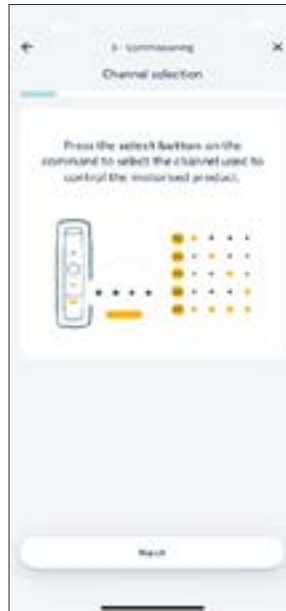

▲ Image 25.17

Synchronising pergolas with more two motors

If the installation is a 5000x4000 pergola the roof motors need to be synchronised choose option B

- 5000x4000 = Option B

If the installation is listed below the pergola only has a single motor, skip ahead to step 18

- 3000x3000 = Option A
- 4000x3000 = Option A
- 5000x3000 = Option A
- 4000x4000 = Option A

25.18

Follow on screen

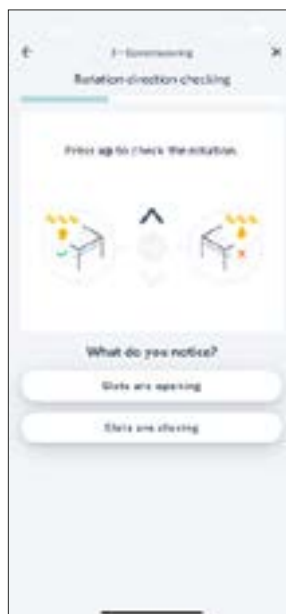

▲ Image 25.18

25.19

Change motor direction if incorrect



▲ Image 25.19

25 Somfy App – Roof commissioning guide continued

25.20

Choose option **B**



▲ Image 25.20

25.21

Choose option **B**



▲ Image 25.21

25.22

Louvres closed and flat

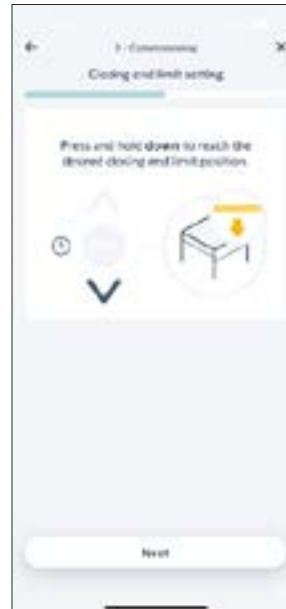

▲ Image 25.22

25.23

Follow instructions

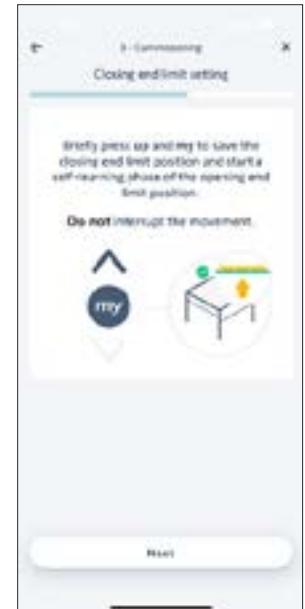

▲ Image 25.23

25.24

Move louvres to half open position



▲ Image 25.24

25.25

Validate the settings

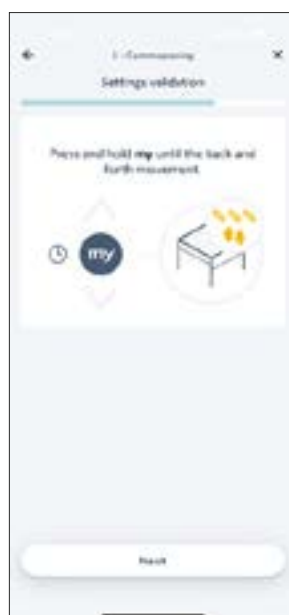

▲ Image 25.25

25.26

Save remote settings



▲ Image 25.26

25.27

Settings now saved

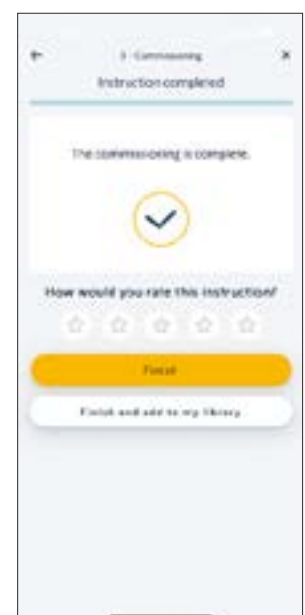

▲ Image 25.27

26 Somfy App – Connectivity kit commissioning guide

26.1

Commissioning the Somfy connectivity Kit to enable use of Tahoma Home control App, to be completed after pairing the remote control.

Open the Somfy Connectivity Kit and scan the QR code on the front of the unit and download the app.



▲ Image 26.1

26.2

Follow the steps on screen

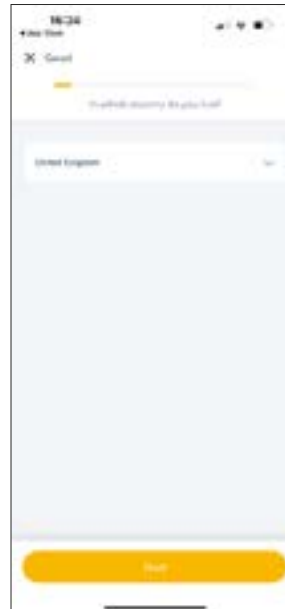

▲ Image 26.2

26.3

Select connectivity kit



▲ Image 26.3

26.4

Select correct option

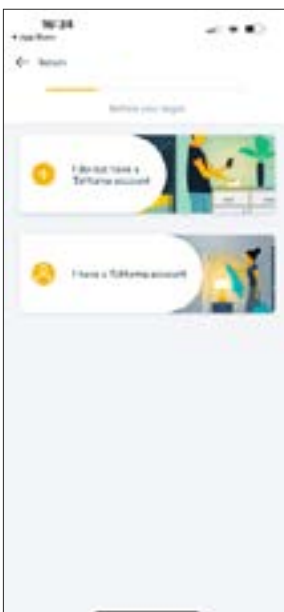

▲ Image 26.4

26.5

Connect kit to power and follow instructions



▲ Image 26.5

26.6

Follow instructions



▲ Image 26.6

26.7

Create Somfy account



▲ Image 26.7

26 Somfy App – Connectivity kit commissioning guide continued

26.8
Continue with account setup



▲ Image 26.8

26.9
Create password



▲ Image 26.9

26.10
Continue account setup



▲ Image 26.10

26.11
Continue setup



▲ Image 26.11

26.12
Connectivity kit update



▲ Image 26.12

26.13
Update in progress



▲ Image 26.13

26.14
Update now complete

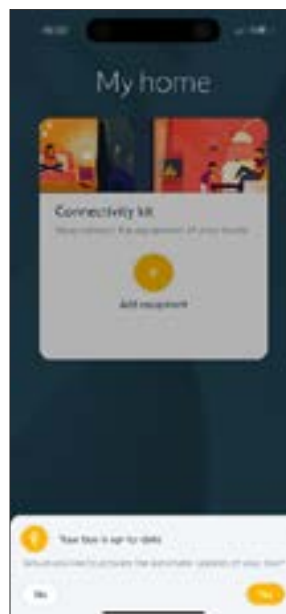

▲ Image 26.14

26.15
The app is now ready to add your equipment

27 Somfy App – Setting up your equipment

27.1
Select 'Add Equipment'

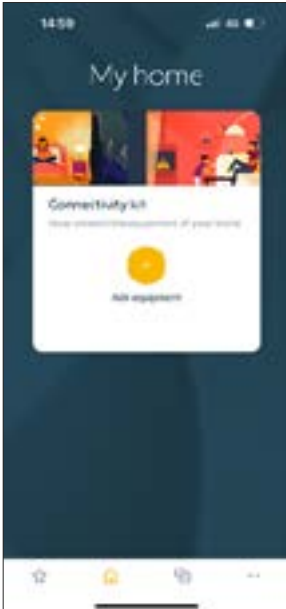

▲ Image 27.1

27.2
Select 'Terrace'



▲ Image 27.2

27.3
Select 'Pergolas'



▲ Image 27.3

27.4
Select 'Remote Control'



▲ Image 27.4

27.5
Scan the QR on the rear of the remote.



▲ Image 27.5

27.6
Select channel 1 to control the Pergola roof



▲ Image 27.6

27.7
Searching for item



▲ Image 27.7

27.8
Pergola Box



▲ Image 27.8

27 Somfy App – Setting up your equipment continued

27.9

Associate with garden

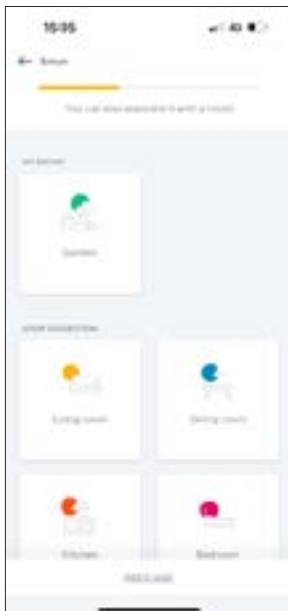

▲ Image 27.9

27.10

Rename if required and validate

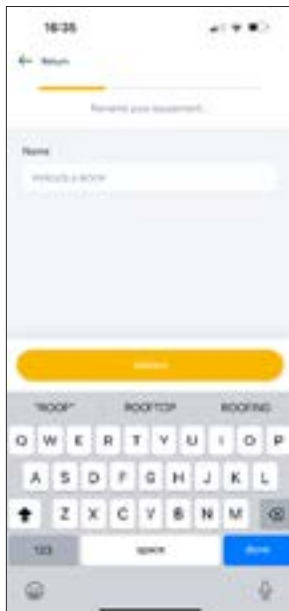

▲ Image 27.10

Now add lighting

27.11

Select 'Add equipment'



▲ Image 27.11

27.12

Select 'lighting & plugs'



▲ Image 27.12

27.13

Select 'Somfy'



▲ Image 27.13

27.14

Select 'Micro Receiver'



▲ Image 27.14

27.15

Select 'Somfy remote control'



▲ Image 27.15

27 Somfy App – Setting up your equipment continued

27.16
Select 'io home control'

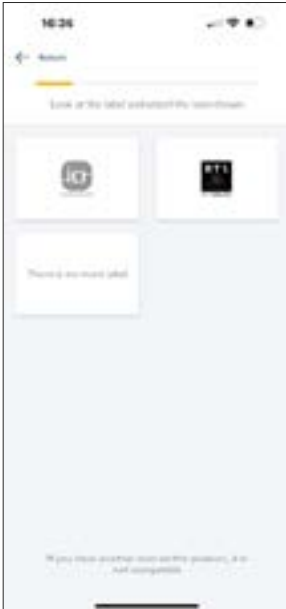

▲ Image 27.16

27.17
Select 'option 2'



▲ Image 27.17

27.18
Select channel 2 on remote

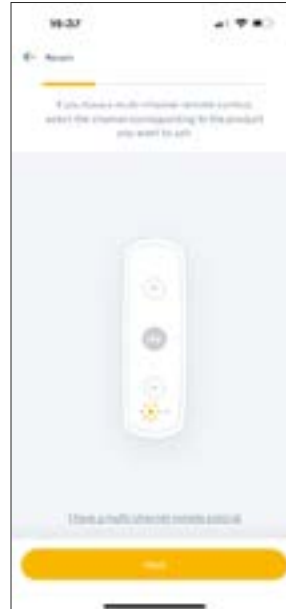

▲ Image 27.18

27.19
Press button on back of remote until light reacts



▲ Image 27.19

27.20
Searching for device



▲ Image 27.20

27.21
Device found, select 'next'



▲ Image 27.21

27.22
Rename if desired then select Validate.



▲ Image 27.22

Now add blinds

27 Somfy App – Setting up your equipment continued

27.23

Select 'Add equipment'



▲ Image 27.23

27.24

Select 'window and sun protection'



▲ Image 27.24

27.25

Select 'shutters'



▲ Image 27.25

27.26

Select 'shutters'



▲ Image 27.26

27.27

Select 'Remote control'



▲ Image 27.27

27.28

Scan QR on reverse of remote



▲ Image 27.28

27.29

Select desired channel on remote then press next

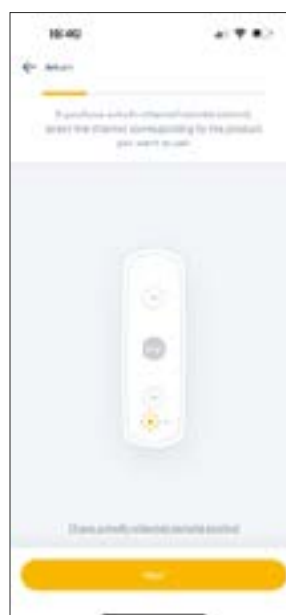

▲ Image 27.29

27.30

Searching for products



▲ Image 27.30

27 Somfy App – Setting up your equipment continued

27.31

Products discovered, select 'Next'



▲ Image 27.31

27.32

The items named Maestria are the blinds, select one at a time



▲ Image 27.32

27.33

Rename blinds



▲ Image 27.33

27.34

Associate with the garden. Now validate

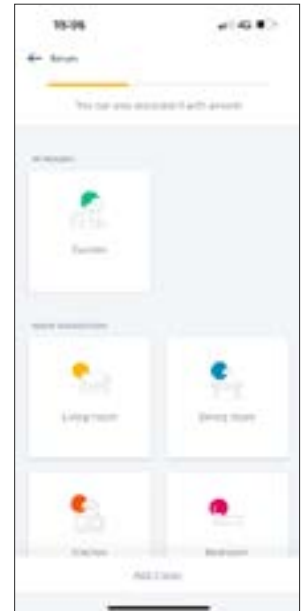

▲ Image 27.34

27.35

Setup is now completed, and all items are ready to operate.



▲ Image 27.35



▲ Image 27.35

Call us +44 (0)1753 212 950
Email info@londonstone.co.uk
Buy online www.londonstone.co.uk

Visit our *inspirational* showrooms

